

# i.am™ 600 and 850



600 foot



850 foot

i.am™ 600 and 850 use an adjustable beam design - meaning the legs can be positioned along the beam to either increase or decrease the length of the base.

## technical details

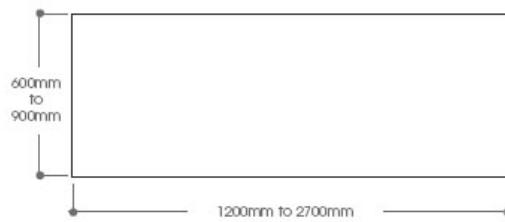

model 600

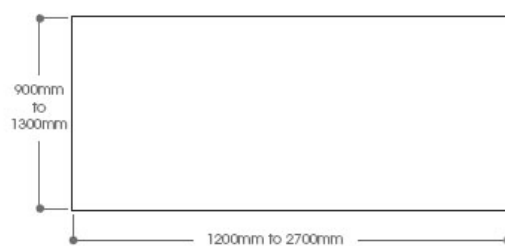
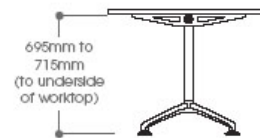

model 850

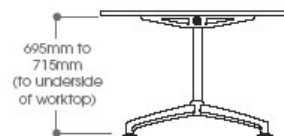

## note



Gullwing™ power box

i.am™ turn



i.am™ turn is offered as a tilt-top stacking option for desks that require movement. Suitable for hot-desking, breakout areas and offices that require constant change, i.am™ can quickly and easily be tilted, moved and stored.



optional mesh modesty



optional cable tray



handle detail

## technical details

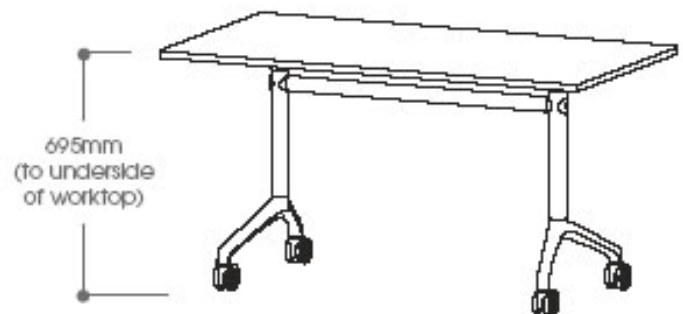

# i.am™ 4 and 5 star



i.am™ will accommodate circular and oval table tops using matching components that are used for desks and tables. This allows for uniformity throughout the work environment and complete flexibility of design.

## technical details

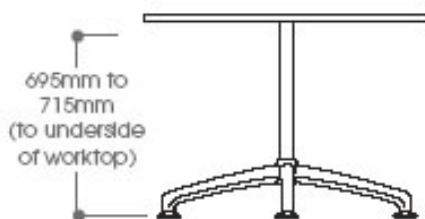
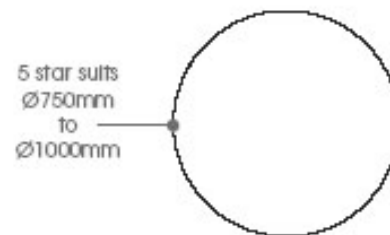
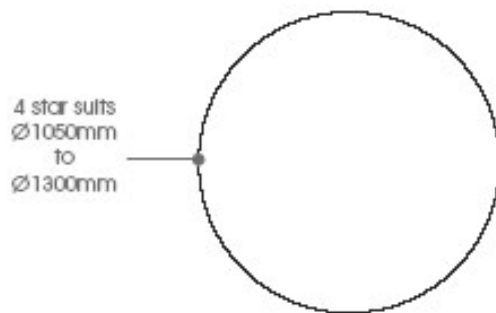

# i.am™ 4 star multi-leg



For larger circular and oval table tops i.am™ comes in a multi-leg base. Large table tops with diameters up to 2100mm can be accommodated. The multi-leg options help complete the i.am™ family of product options for the commercial environment.

## technical details

